

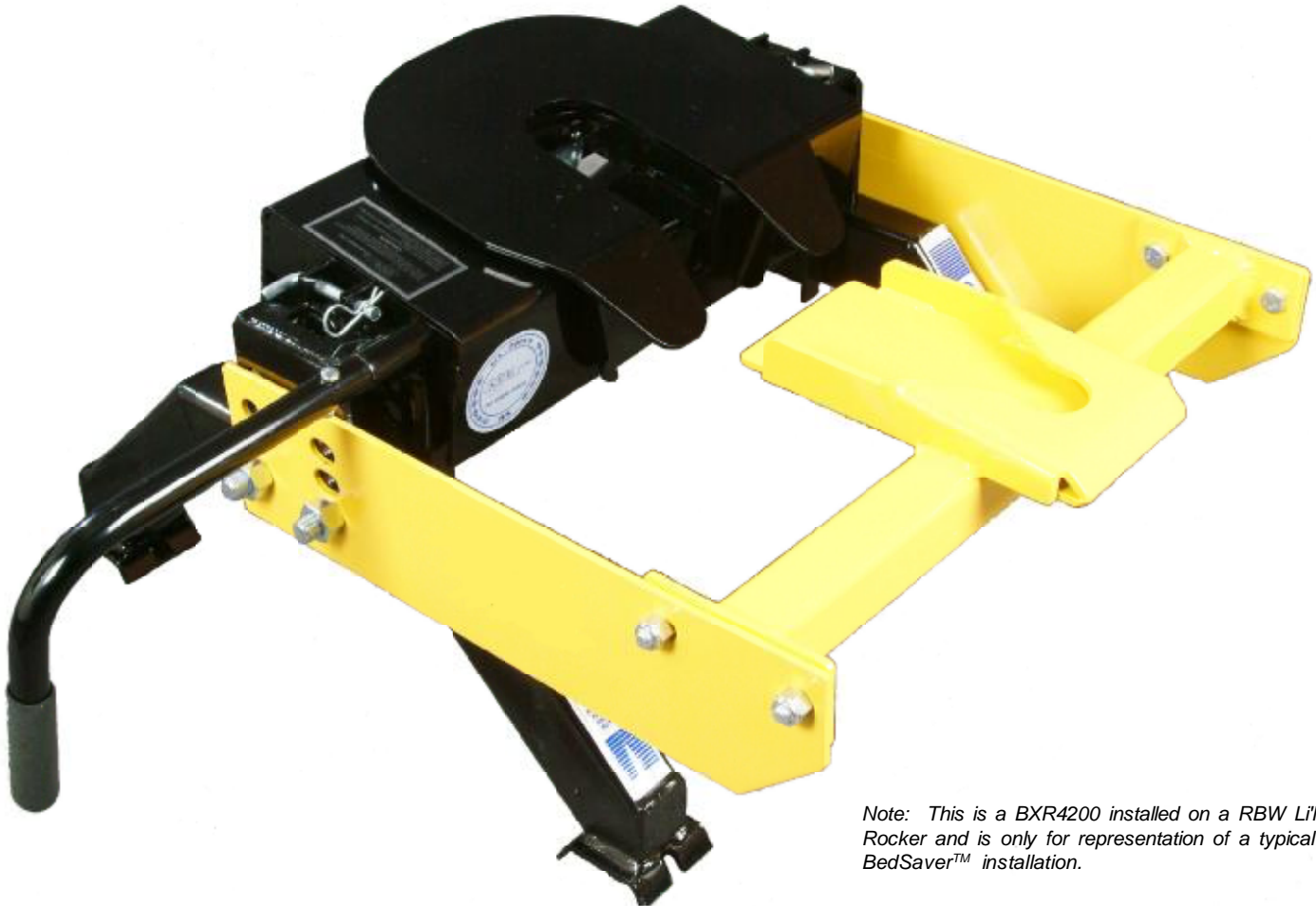

Strong As An Ox™

BedSaver™

Serial No.



Note: This is a BXR4200 installed on a RBW L'il Rocker and is only for representation of a typical BedSaver™ installation.

Operator and Installation Manual BXR4104 Reese Pro 15K Sliders

Unless otherwise specified, the bedsaver will NOT work with aftermarket pin boxes. See fit list.

TO BE VALID, THE WARRANTY CARD MUST BE COMPLETED IN ITS ENTIRETY BY AN AUTHORIZED DISTRIBUTOR OR DEALER AND SENT TO AUTOMATIC EQUIPMENT MFG. CO., PENDER, NEBRASKA OR REGISTERED ONLINE AT www.blueox.us. FAILURE TO DO SO WILL VOID THE WARRANTY.



Strong As An Ox™

Safety Information

SPECIAL DANGER MESSAGE

The act of uncoupling your fifth wheel trailer from your tow vehicle is, singularly, the most dangerous act to be performed when RVing. Many accidents have occurred where broken bones, severed limbs and even death by crushing have resulted from inadvertently dropping the fifth wheel trailer when a person has placed part of his/her body between the tow vehicle and the frame of the fifth wheel trailer. All of these accidents are completely avoidable by following a few simple rules, even without installing BedSaver™ on your hitch.

- Chock your trailer wheels.
- Extend your front jacks until you see no weight is on the hitch.
- NEVER place any part of your body between the trailer frame and tow vehicle or hitch.
- NEVER allow any helper or observer to place any body part between the trailer frame and tow vehicle or hitch.

BedSaver™ prevents damage to your tow vehicle™ when an inadvertent release happens. BedSaver™ may NOT prevent injury to someone violating the simple rules above.

For everyone's good, and for a safe and happy RVing experience, follow the above rules and NEVER COMPROMISE them.

Safety Information

- 1) Blue Ox™ strongly recommends dealer installation and/or by a certified technician.
- 2) DO NOT ATTEMPT TO INSTALL THIS PRODUCT WITHOUT FIRST READING THESE INSTRUCTIONS.
- 3) WARNING! FAILURE TO INSTALL THIS PRODUCT PROPERLY CAN RESULT IN DAMAGE TO YOUR FIFTH WHEEL TRAILER, TOW VEHICLE, FIFTH WHEEL HITCH AND/OR CAUSE BODILY INJURY.
- 4) This product is not designed or intended for use with fifth wheel trailers having a pin weight of 4000 pounds or more.
- 5) Your BedSaver™ should be inspected for damage after each incident. Note: An incident is defined as any time BedSaver™ catches your trailer.

If the bedsaver is in a incident, it must be replaced. DO NOT use it again! An incident can cause unseen damage and using it again could result in more damage or serious injury. DO NOT use the bedsaver if it is damaged or missing parts.

Special Messages

“NOTE” provides enhancement information pertinent to the specific step of the procedure being undertaken.

“CAUTION” indicates a potential hazard exists that could result in damage to the tow vehicle, fifth wheel trailer or the fifth wheel hitch.

“WARNING” indicates a potential hazard exists that could result in personal injury, or death

Assumptions

It is assumed that you have the Reese or DrawTite 14 – 16K, 14 – 16K Slider, Pro 15 K, or Pro 15K Slider hitch installed properly. If not, have your hitch installed by a certified technician.



Strong As An Ox™

Parts List

Inspect the parts in your kit and check them off against the pictures and parts list below.

<u>Qty</u>	<u>Description</u>	<u>Picture #</u>
1	Cross tube Weldment	1
2	Side plate	2
8	Bolt, 1/2"-13 X 1 1/4", Zinc Plated	3
8	Lock Nut, Nylock, 1/2"-13, Zinc Plated	4

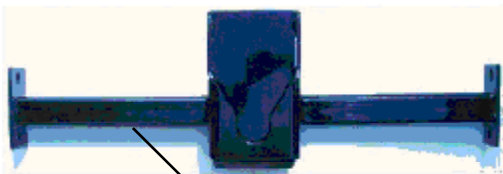

Picture 1



Picture 2



Picture 3



Picture 4

Location of Serial & Model #'s

If any of these parts are missing refer to page 6 for part numbers then, call a Blue Ox™ dealer or the factory.

Tools Required

3/4" Socket

3/8" Drive Ratchet

3/4" Comb. Wrench

Torque Wrench

NOTE: The illustration in the preceding instructions shows a DrawTite Hitch. This procedure remains the same for your Reese hitch. For this procedure, consider the Reese and DrawTite hitches to be the same. Any differences will be specified in the appropriate steps.

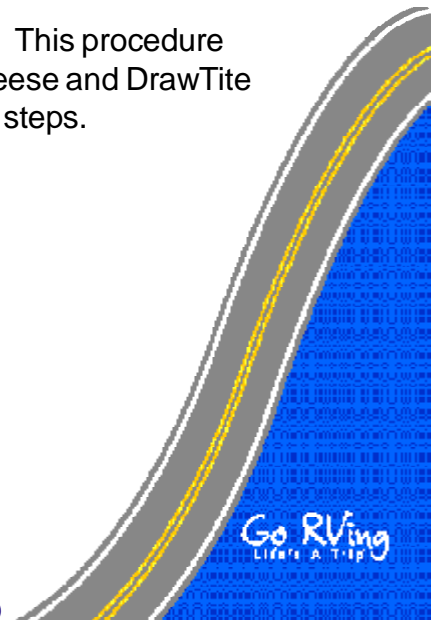



Strong As An Ox™

Installation

Requirements for placement of BedSaver™ Side Plates

The BedSaver™ Side Plates are mounted with the bottom mounting holes aligned with the Hitch Side Frame bottom mounting holes. The BedSaver™ Side Plates are mounted with the beveled corners located on the bottom and toward the rear of the tow vehicle.

Note: You will find a label on each Side Plate. The labels should be placed to the outside of the hitch.

Step 1

Examine the hitch, particularly the positioning of mounting bolts securing the Hitch Side Frames (these mount the Hitch Head Cradle to the side supports). There are four pairs of mounting holes. Counting from the bottom pair of mounting holes (bottom = 1, top = 4), take note of the pair of mounting holes in which the bolts are installed. If the bolts are located in **position 1, 2 or 3**, proceed to **Step 2** below. If the bolts are located in **position 4**, skip **Step 2** and proceed to **Step 8** on page 3.



Figure 1-Determining Side Frame mounting bolts location



Figure 2-Left Side Frame Mounting Nuts removed

Step 2

Referring to Figure 2, remove the two left side frame mounting nuts (and lock washers). Do not remove the bolts.

Step 3

Remove the two right side frame mounting nuts (and lock washers). Do not remove the bolts

Step 4

Using the Left Side Plate provided in the kit and referring to **Figure 3** on page 3, slide it onto the existing mounting bolts on the Hitch Left Side Frame. Make certain you align the bottom holes of the Side Plate with the bottom holes of the Side Frame.

Step 5

Using the Right Side Plate provided in the kit, slide it onto the existing mounting bolts on the Hitch Right Side Frame. Make certain you align the bottom holes of the Side Plate with the bottom holes of the Side Frame.

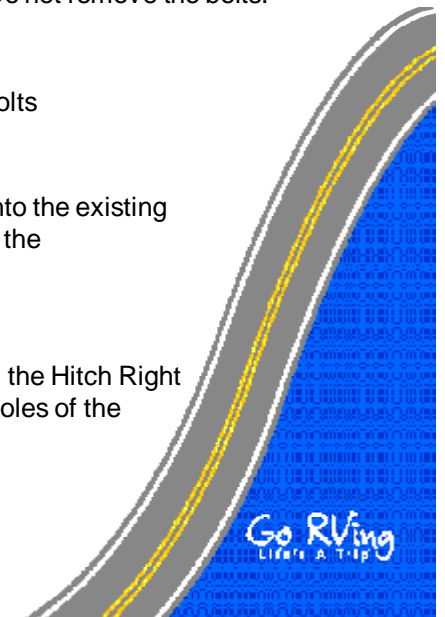



Strong As An Ox™

Installation Cont.



Figure 3-Left Side Plate installation



Figure 4-Left Side Plate attached

Step 6

Referring to **Figure 4**, reinstall the two lock washers and mounting nuts on the original mounting bolts securing the Left Side Plate. Finger tighten only. Now install two of the bolts and elastic stop nuts provided in the kit into the bottom mounting holes with the bolt shank to the outside. Finger tighten only.

Step 7

Reinstall the two lock washers and mounting nuts on the original mounting bolts securing the Right Side Plate. Finger tighten only. Now install two of the bolts and elastic stop nuts provided in the kit into the bottom mounting holes with the bolt shank to the outside. Again, finger tighten only.

Step 8

If you referred to this step from **Step 1**, then your Hitch Side Frames are mounted using the holes in **position 4**. Simply install each BedSaver™ Side Plate to each Hitch Side Frame using two bolts and Nylok nuts provided in the kit and aligning the bottom holes of each Side Plate to the bottom holes in the Hitch Side Frames. Finger tighten the nuts.

NOTE: If the BedSaver™ Side Plates are each mounted using only two bolts and nuts, this is OK. The strength of the BedSaver™ is not compromised.



Strong As An Ox™

Cross Tube Installation

Step 9

Refer to **Figure 5**, below for details. Using the remaining four bolts and Nylok nuts supplied with the kit, attach the Cross tube Weldment to the left and right Side Plates. Insert the bolts with the heads on the outside and finger tighten the nuts.

Step 10

Inspect the Side Plates and Cross tube for proper placement. When satisfied that it appears correct, tighten the eight nuts securing the Side Plates to the hitch frame, then tighten the four nuts and bolts attaching the Cross tube to the Side Plates.

Torque all nuts to 65 foot-pounds.

NOTE: When tightening the Side Plates to the hitch frame sides, it may be necessary to lift the Side Plate for proper alignment and leveling.

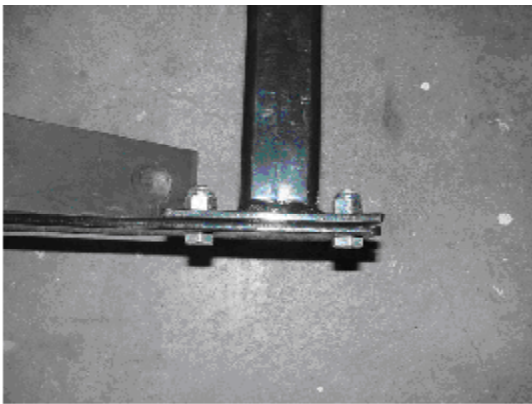

Figure 5-Cross tube attachment, left side



Figure 6-Complete installation, rear



Figure 7-Complete installation, top view

Step 11

Inspect your work and check to be certain all nuts and bolts have been properly tightened. A sample installation is shown in **Figures 6 and 7**. These two figures depict the yellow display version.



Strong As An Ox™

Parts List

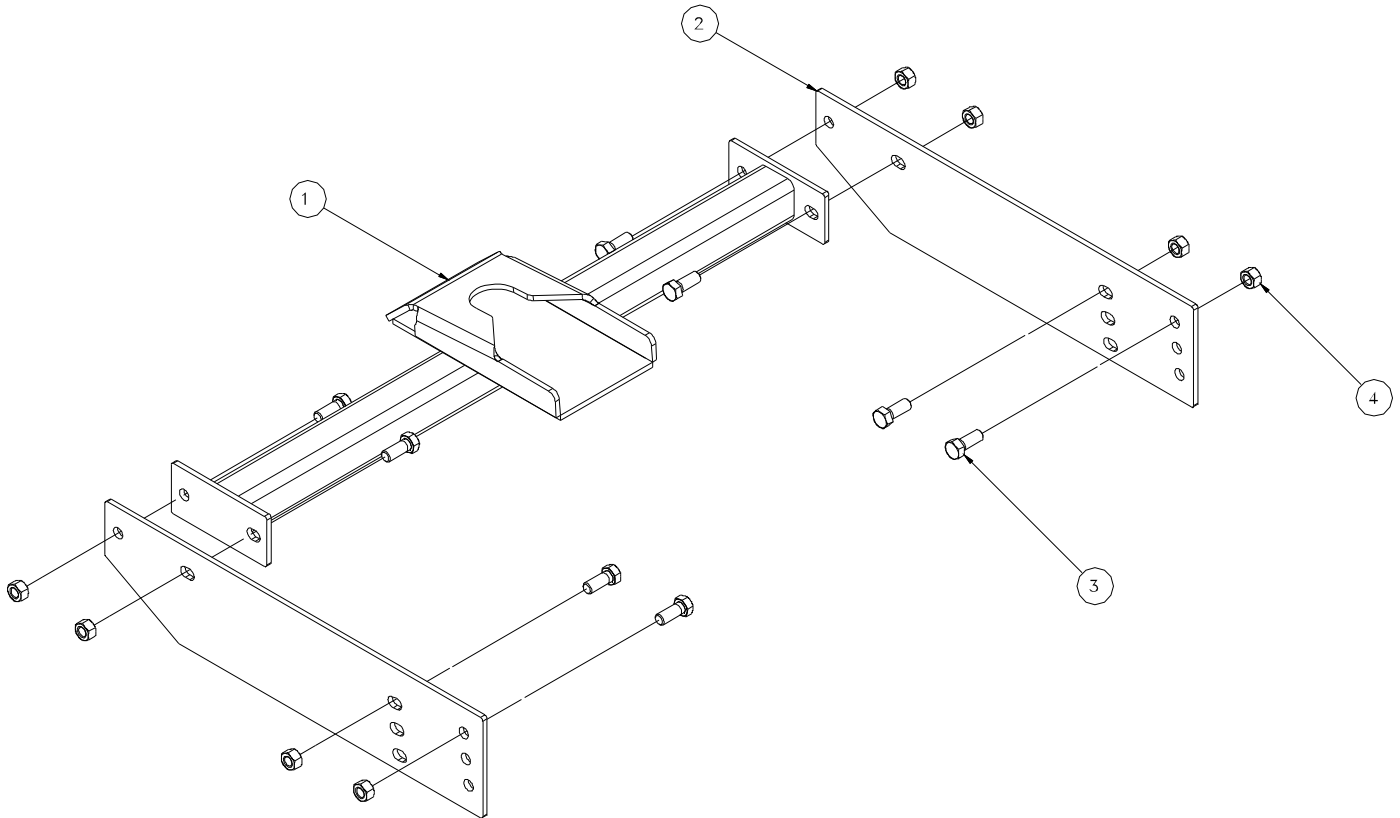

Parts List

Ref. No.	Qty.	Part No.	Description
1	1	61-6110	WLDM'T, BEDSAVER X-TUBE, 24 1/4
2	2	101-6762	PLATE, BEDSAVER SIDEPLATE, BXR4104
3	8	201-0011	1/2-13 X 1 1/4 HEX BOLT GRD.5, ZP
4	8	202-0094	1/2-13 HEX NYL. INS. LOCK NUT, ZP

IMPORTANT: Use only genuine factory replacement parts on your bracket kit. Do not substitute homemade or nontypical parts. If a bolt is lost or in need of replacement, for your safety and the preservation of your bracket kit, be sure to use a replacement bolt of the same grade. Repair parts may be ordered through your nearest **Blue Ox™** dealer or distributor.

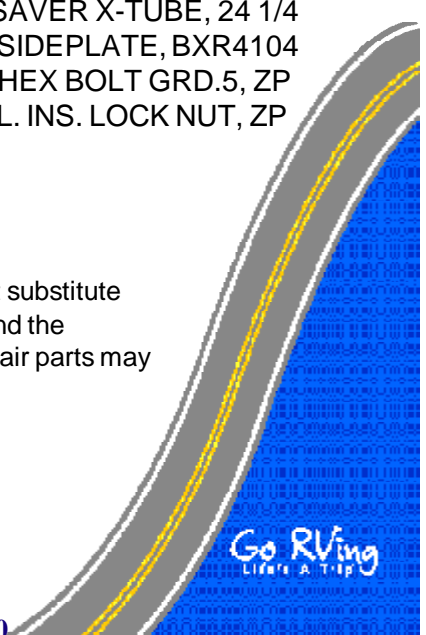

Go RVing
LIVE A LITTLE